

























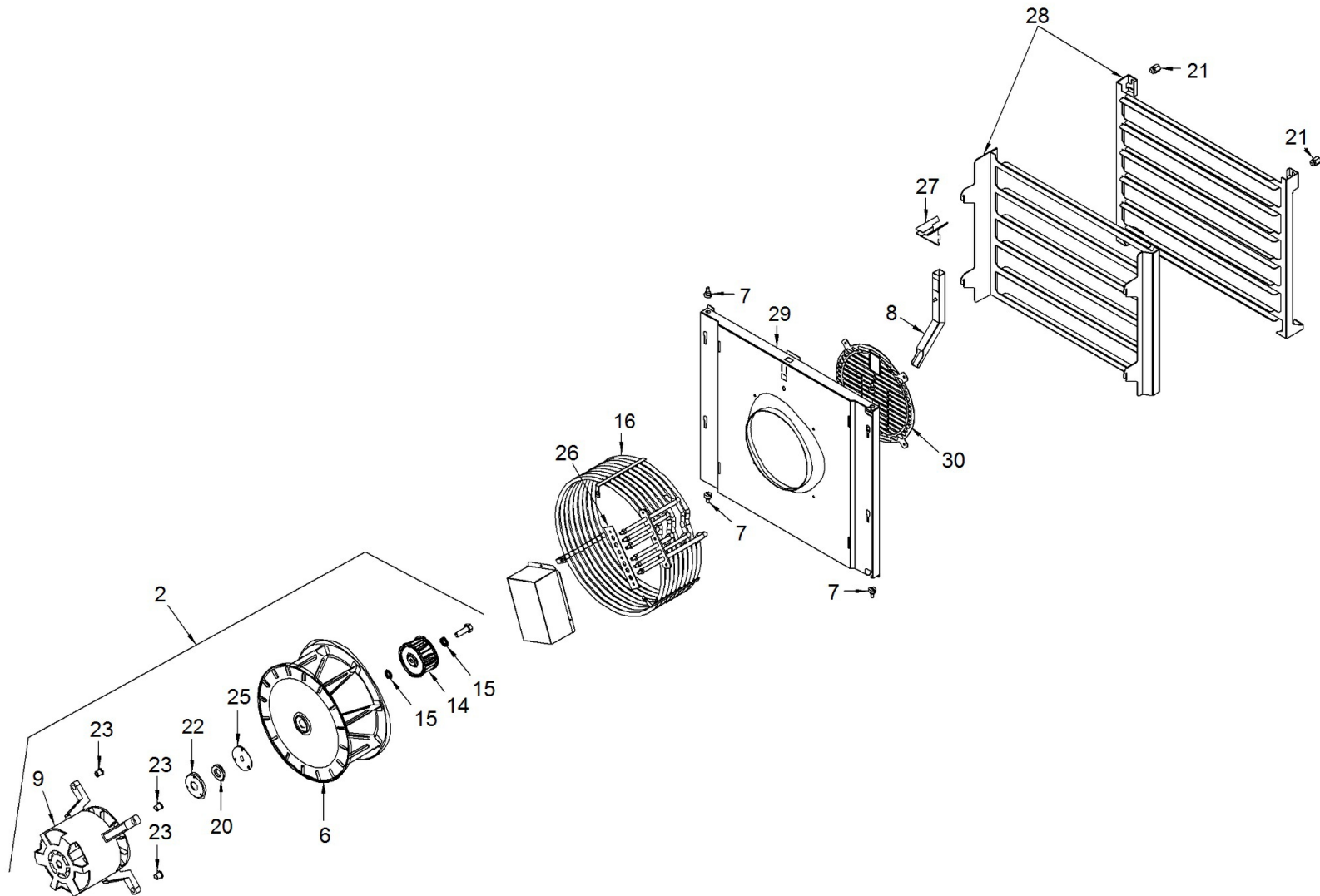

















1
HOME / FOURS MIXTES ET A AIR PULSE / FX / FX61E2 / K001880-COMPOSANTS LAVAGE / 1

	Modification	  	Code	 	Description	 	Cons.	Qtè Date validité
			1 3003400		RACCORD		X	1 15/12/2009-
			2 3014470		RACCORD À 90°		X	1 15/12/2009-
			4 3142690		RACCORD DROIT M1/8"		X	1 15/12/2009-
			5 3151441		JOINT Ø22Ø16.2=1.5 CU		X	1 15/12/2009-
			6 3157710		MANCHON			1 15/12/2009-
			7 6300745		EROGATEUR EAU COMP.		X	1 15/12/2009-07/02/2011
			8 131AA35		TUYAU EN TÉFLON Ø8-Ø6		X	75 15/12/2009-
			9 33Q6650		RACCORD		X	1 15/12/2009-

1
HOME / FOURS MIXTES ET A AIR PULSE / FX / FX61E2 / K001840-GROUPE MOTEUR + TURBINE / 1



1
HOME / FOURS MIXTES ET A AIR PULSE / FX / FX61E2 / K001840-GROUPE MOTEUR + TURBINE / 1

	Modification	  Code	 Opt.	Description	 Cons.	Qtè Date validité
		2 6300715		GROUPE MOTEUR	X	1 15/12/2009-
		3 3016470		VIS TH M10X35	X	1 15/12/2009-
		6 3081520		VENTILATEUR RADIAL §285 (POUR UN FX101 60Hz)	X	1 15/12/2009-
		7 3084430		VIS TE M6 Ø16x23		4 15/12/2009-10/02/2015
		7 3278390		VIS	X	4 11/02/2015-
		8 3180070		TUYAU TERMINAL		1 15/12/2009-
		9 3103750		MOTEUR 0,70 kW		1 15/12/2009-24/01/2024
		9 6301393		GROUPE MOTEUR + COUSSINET	X	1 25/01/2024-
		14 3115410		DIFFUSEUR	X	1 15/12/2009-
		15 3115420		UNTERLEGSCHHEIBE	X	2 15/12/2009-
		16 3116030		RESISTANCE 9.5KW 230V	X	1 15/12/2009-
		20 3121930		ROULEMENTS	X	1 15/12/2009-
		21 36C3071		PIVOT M6 PORTE-CUVETTES		2 15/12/2009-10/02/2015
		21 3278380		PIVOT M6 PORTE-CUVETTES	X	2 11/02/2015-
		22 36E3160		SUPPORT BAGUE D'ÉTANCHÉITÉ	X	1 15/12/2009-
		23 36H0890		BAGUE	X	4 15/12/2009-
		25 37Q0250		JOINT	X	1 15/12/2009-
		26 37Q3220		JOINT		1 15/12/2009-30/08/2016
		26 3332550		JOINT	X	1 31/08/2016-
		27 3137010		CUVETTE		1 15/12/2009-26/09/2013

1
HOME / FOURS MIXTES ET A AIR PULSE / FX / FX61E2 / K001840-GROUPE MOTEUR + TURBINE / 1





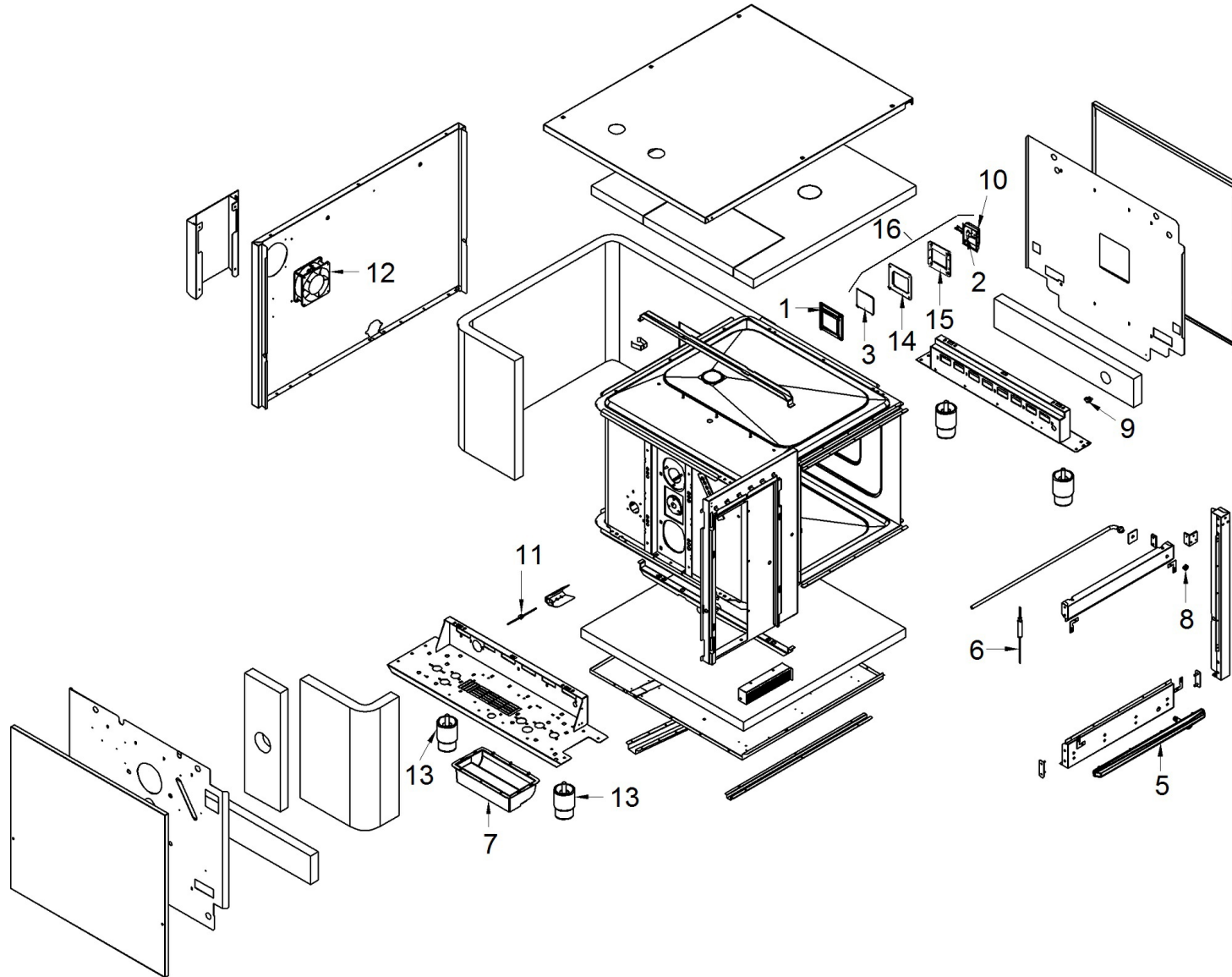













	Modification	  	Code	 	Opt.	Description	 	Cons.	Qtè	Date validité
			27 3137011			CUVETTE				1 27/09/2013-19/04/2023
			27 3137012			CUVETTE		X		1 20/04/2023-
			28 6300828		B	PAIRE DE PLATEAU DE DIAMANTS		X		1 15/12/2009-
			28 6300863		A	PAIRE DE PLATEAU				1 15/12/2009-
			29 3164330			CONVOYEUR				1 15/12/2009-
			30 3238000			GRILLE CONVOYEUR				1 15/12/2009-

1
HOME / FOURS MIXTES ET A AIR PULSE / FX / FX61E2 / 1









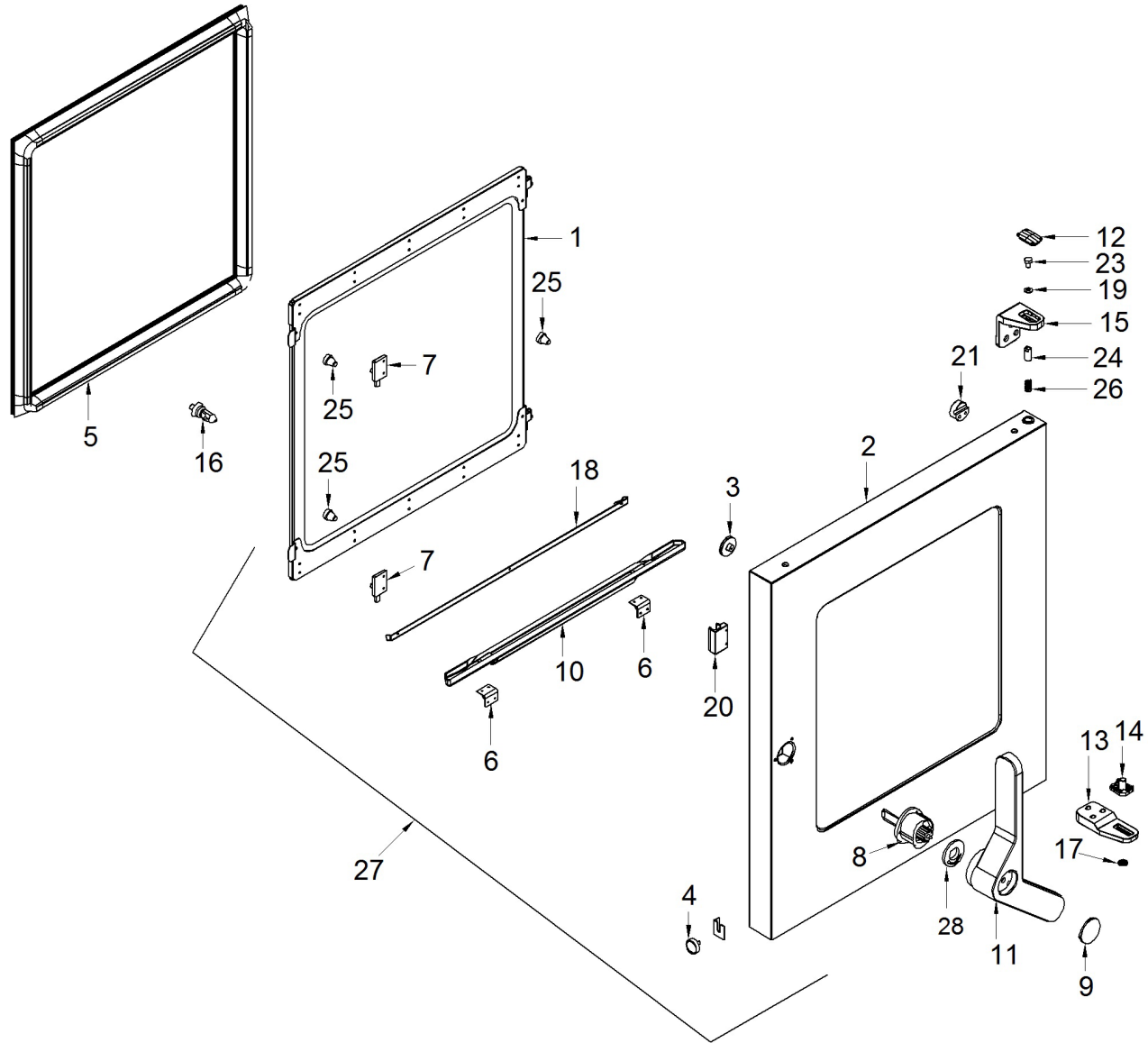

















	Modification	 ↑↓	Code	↑↓ Description	↑↓ Cons.	Prix ↑↓	Qtè Date validité
		1	3159800	GRILLE LAMPE		0,00	1 15/12/2009-13/01/2015
		1	3278370	GRILLE LAMPE		0,00	1 14/01/2015-02/03/2020
		1	3278371	GRILLE LAMPE	X	16,47	1 03/03/2020-
		2	3030660	HALOGENLAMPE		0,00	1 15/12/2009-30/11/2014
		2	3030661	HALOGENLAMPE	X	6,58	1 01/12/2014-
		3	3036960	VERRE LAMPE		0,00	1 15/12/2009-16/01/2012
		3	3036961	VERRE LAMPE		0,00	1 17/01/2012-06/08/2012
		3	3036962	VERRE LAMPE		0,00	1 07/08/2012-14/07/2016
		3	3036963	VERRE LAMPE		0,00	1 15/07/2016-25/02/2020
		3	3036964	VERRE LAMPE	X	25,21	1 26/02/2020-
		4	3036970	GARNITURE	X	6,73	1 15/12/2009-06/08/2012
		4	0000000	-		0,00	0 07/08/2012-
		5	3103120	BAC		0,00	1 15/12/2009-31/08/2012
		5	3215200	BAC	X	7,86	1 01/09/2012-
		6	3139610	THERMORÉSISTANCE PT1000	X	158,72	1 15/12/2009-14/09/2023
		6	3447570	SONDE A POINTEAU	X	206,62	1 15/09/2023-
		7	3116860	LOGEMENT		0,00	1 15/12/2009-
		8	3121370	DOUILLE		7,56	1 15/12/2009-
		9	32D1450	BORNE	X	2,09	2 15/12/2009-
		10	32V5570	LAMPE COMPLÈTE	X	21,06	1 15/12/2009-













1
HOME / FOURS MIXTES ET A AIR PULSE / FX / FX61E2 / 1

	Modification	  	Code	 	Description	 	Cons.	Prix  	Qtè Date validité
			11 32V5750		THERMORÉSISTANCE PT1000		X	76,10	1 15/12/2009-
			12 32V5790		VENTILATEUR 20W 120mm		X	32,62	1 15/12/2009-01/05/2012
			12 3205940		VENTILATEUR 20W 120mm			0,00	1 02/05/2012-20/02/2013
			12 32V5790		VENTILATEUR 20W 120mm		X	32,62	1 21/02/2013-
			13 36D5732		PIED		X	17,14	4 15/12/2009-
			14 36E3170		JOINT LAMPE		X	6,08	1 15/12/2009-
			15 3324500		FLASQUE		X	19,34	1 15/12/2009-
			16 6301165		KIT LAMPE		X	115,15	1 15/12/2009-



	Modification	 ↑↓	Code	↑↓ Description	↑↓ Cons.	Qtè Date validité
		1	6300693	VERRE INTÉRIEUR PORTE COMP.		1 15/12/2009-30/06/2011
		2	6300710	VERRE EXTÉRIEUR PORTE COMP.		1 15/12/2009-
		3	3004870	BLOCAGE FIL SONDE		1 15/12/2009-29/05/2010
		3	3174310	BLOCAGE FIL SONDE		1 30/05/2010-
		4	3008810	MAGNETO	X	1 15/12/2009-
		5	3077260	JOINT FAÇADE		1 15/12/2009-30/06/2011
		6	3085860	CHARNIERE	X	2 15/12/2009-
		7	3085950	SERRURES		2 15/12/2009-30/06/2011
		8	3088480	SERRURE À COIN		1 15/12/2009-07/02/2011
		8	3088481	SERRURE À COIN		1 08/02/2011-20/09/2016
		9	3104151	BOUCHON		1 15/12/2009-23/10/2012
		10	3104170	BAC		1 15/12/2009-31/05/2022
		11	3104201	POIGNEE		1 15/12/2009-23/10/2012
		12	3108261	BOUCHON		1 15/12/2009-23/10/2012
		13	3108730	CHARNIÈRE INFÉRIEUREPORTE	X	1 15/12/2009-
		14	3108740	SUPPORT PORTE INF.		1 15/12/2009-17/11/2015
		15	3108760	CHARNIÈRE SUPÉRIEURE PORTE	X	1 15/12/2009-
		16	3108770	PIVOT		1 15/12/2009-21/07/2014
		17	3115570	RONDELLE	X	1 15/12/2009-
		18	3116521	GOUTTIÈRE	X	1 15/12/2009-

2
HOME / FOURS MIXTES ET A AIR PULSE / FX / FX61E2 / K001860-GROUPE PORTE / 2

	Modification	 ↑↓	Code	↑↓ Description	↑↓ Cons.	Qtè Date validité
			19 3120060	RONDELLE §12 §6.4=1.6		1 15/12/2009-
			20 3121360	SUPP. SONDE		1 15/12/2009-29/05/2010
			20 3167770	SUPP. SONDE		1 30/05/2010-04/04/2012
			21 3121380	BLOCAGE FIL SONDE		1 15/12/2009-11/01/2012
			22 3329020	RESSORT	X	1 08/02/2011-
			23 31A0560	VIS M6X10 INOX		1 15/12/2009-
			24 36D7062	PIVOT71AR	X	1 15/12/2009-
			25 36E2780	BUTÉE PORTE		3 15/12/2009-30/06/2011
			26 36G5320	RESSORT A TORSION	X	1 15/12/2009-
			27 6300683	PORTE FOUR COMP.		1 15/12/2009-30/06/2011
			28 3171920	COUSSINET	X	1 25/01/2010-