

REV.: 0 - 01 / 2018

Pos	Réf.	Description	Notes	Valable à p	Valable jus
0001	BN14402200	GRIGLIA POSTER. VANO MOTORE TAVOM-EN'21			
0002	BN16660351	RESISTANCE [R] 45W 3V CADRE DE LA PORTE			
0003	BN1467509	PIEDS 2" ROND H=145-205 TABLES [C]			
0004	BN147824	CASTOR 125 W/BRAKE FOR GRID			
0005	BN147823	WHEEL 125 W/O BRAKE [C]			
0006	BN1471631347	PROFILO COP.CORNICE ORIZ.TAV OMNIA 03			
0007	BN1471640666	PROFILO COP.CORNICE VERT.TAV OMNIAH70-71			
0008	BN1471170600	COUVERCLE DU CADRE [R] EN NEW L. 600			

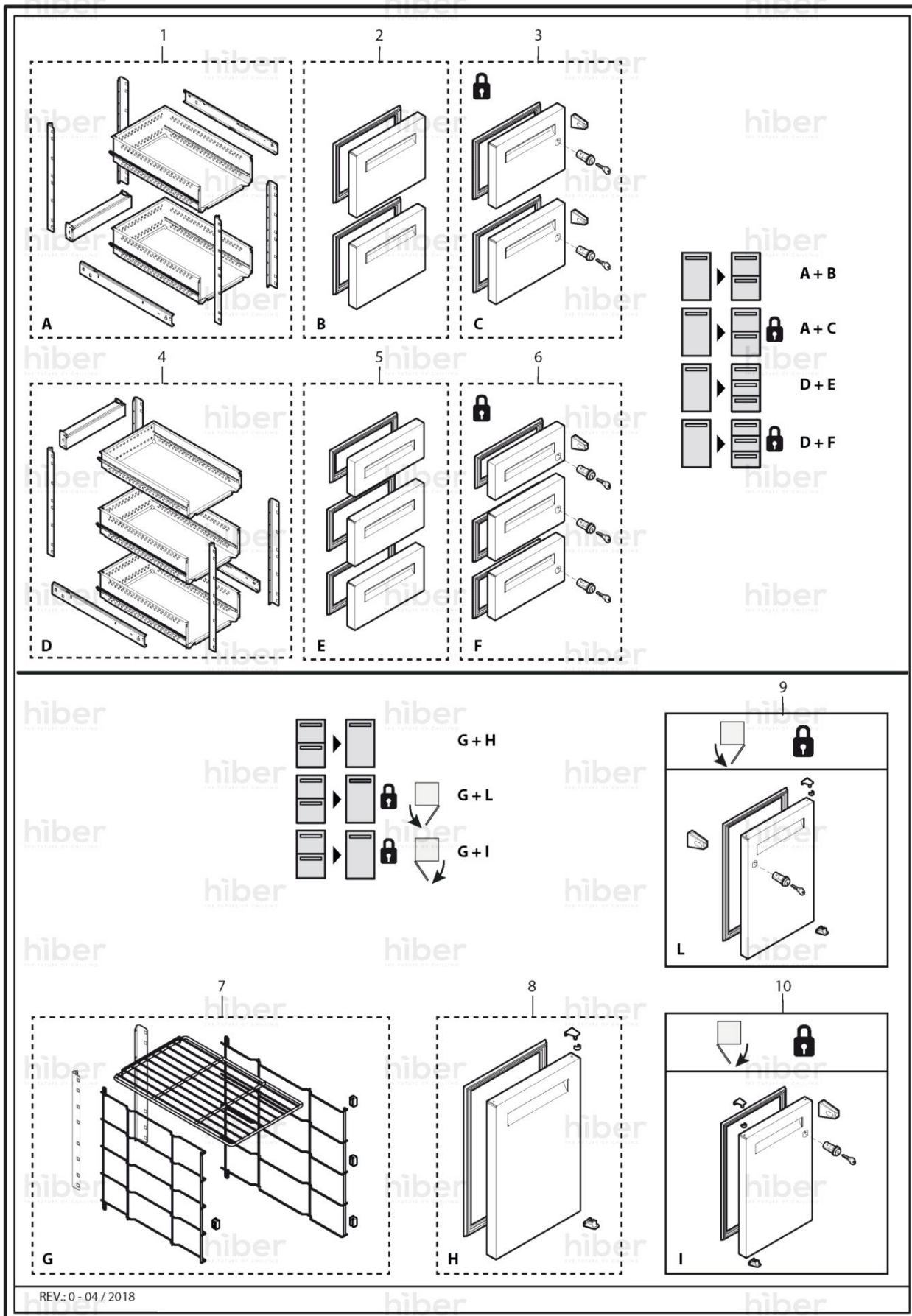

Pos	Réf.	Description	Notes	Valable à p	Valable jus
0001	BN2196040	KIT TIROIRS [C] 1/2 710			
0002	BN2196350	KIT FRONT. CASS.RA 1/2 710 RON. S/SER			
0003	BN2196360	KIT FRONT. CASS.RA 1/2 710 RON. C/SER			
0004	BN2196070	KIT CORPO CASS.RA 1/3 710 PAN.			
0005	BN2196340	KIT FRONT. CASS.RA 1/3 710 RON. S/SER			
0006	BN2196370	KIT FRONT. CASS.RA 1/3 710 RON. C/SER			
0007	BN2196100	KIT EQUIPMENT CABINET [R] TABLE 710			
0008	BN2196380	PORTE [R] 710 RON SANS SERRURE			
0009	BN2196390	KIT ASS.PORTA DX 710 RON C/SER			
0010	BN2196400	KIT ASS.PORTA SX 710 RON C/SER			

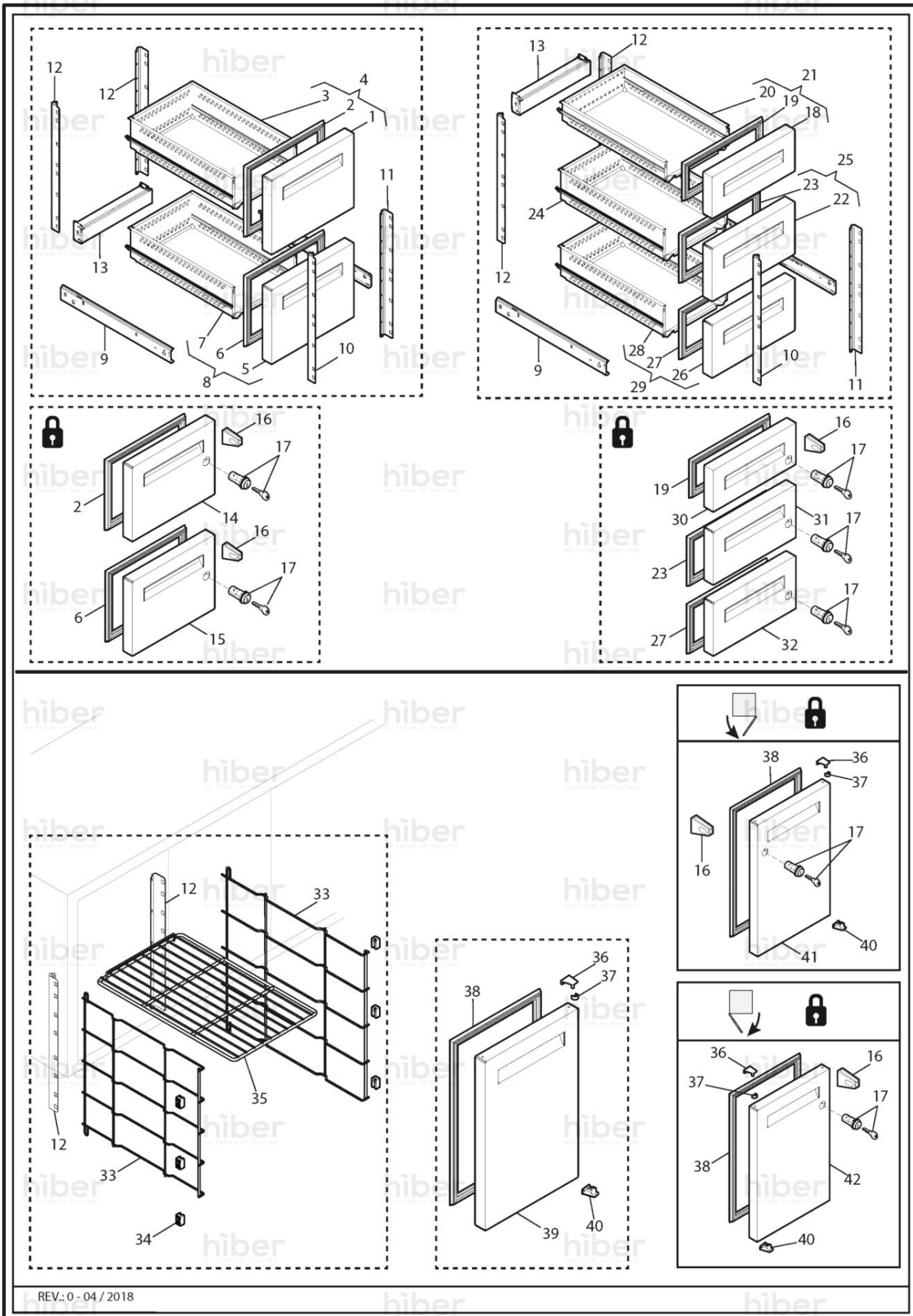

Pos	Réf.	Description	Notes	Valable à p	Valable jus
0001	BN32247100	BOM.CASS.1/2 S/S H70-1 R TAV OM'16 GLK4A			
0002	BN1441289383	JOINT [R] 289X 383			
0003	BN32534150	ASS.INVOLUCRO CASS. H=150TAV OM R1269612			
0004	BN2196300	KIT ASS. CASS. 1/2 710 RON. S/SER			
0005	BN32247100	BOM.CASS.1/2 S/S H70-1 R TAV OM'16 GLK4A			
0006	BN1441289383	JOINT [R] 289X 383			
0007	BN32534150	ASS.INVOLUCRO CASS. H=150TAV OM R1269612			
0008	BN2196300	KIT ASS. CASS. 1/2 710 RON. S/SER			
0009	BN1449560	KIT COPPIA GUIDE TEL.L550 OMNIA XRICAMBI			
0010	BN33587160	MONT.ANT.SX SUP.GUIDE TAV OMNIA H70-71			
0011	BN33587150	MONT.ANT.DX SUP.GUIDE TAV OMNIA H70-71			
0012	BN33587170	@@@MONT.POS.SUP.GUI+GRI.TAV OMNIAH70-71\$			
0013	BN32924300	TRAVERSE [C]			
0014	BN32247100SER	BOM.CASS.1/2 C/S H70-1 RON TAV OM'16			
0015	BN32247100SER	BOM.CASS.1/2 C/S H70-1 RON TAV OM'16			
0016	BN1483180	GACHE SERRURE PORTE+TIROIR TABLE OMNIA			
0017	BN1483300	SERRURE [R]			
0018	BN32246510	BOM.CASS.1/3 SUP S/SER R TAV OM'16 GLK1A			
0019	BN1441144383	JOINT [R] 144X 383 TIROIR 1/3 SUP OMNIA			
0020	BN32534100	ASS.INVOLUCRO CASS. H=100TAV OM R1269611			
0021	BN2194310	KIT ASS. CASS. SUP 1/3 660/710 RON.S/SER			
0022	BN32246520	BOM.CASS.1/3 INF S/SER R TAV OM'16 GLK2A			
0023	BN1441194383	JOINT [R] 194X 383			
0024	BN32534150	ASS.INVOLUCRO CASS. H=150TAV OM R1269612			
0025	BN2196320	KIT ASS. CASS. CEN 1/3 710 RON. S/SER			
0026	BN32246520	BOM.CASS.1/3 INF S/SER R TAV OM'16 GLK2A			
0027	BN1441194383	JOINT [R] 194X 383			
0028	BN32534150	ASS.INVOLUCRO CASS. H=150TAV OM R1269612			
0029	BN2194330	KIT ASS. CASS. INF 1/3 660/710 RON.S/SER			
0030	BN32246510SER	BOM.CASS.1/3 SUP C/SER RON TAV OM'16			
0031	BN32246520SER	BOM.CASS.1/3 INF C/SER RON TAV OM'16			
0032	BN32246520SER	BOM.CASS.1/3 INF C/SER RON TAV OM'16			
0033	BN1440500	SUPPORT [R] TABLE OMNIA			
0034	BN14230010	SUPPORT [R] CHÃ,SSIS TR/TP/TAV			
0035	FR6351760	GRILLE ETAGERE [R] EN PLASTIQUE GN 1/1 530X325			
0036	BN1414400	SUPPORT [R] SUPERIEUR			
0037	BN14230050	ENTRETOISE [C] CHARNIERE PORTE			
0038	BN1441623383	JOINT 623X383 PORTE OMNIA			
0039	BN32637000	BOM.POR.DX-SX S/S H70-1 TAV OM'16 GLX2A			
0040	BN1414450	SUPPORT INFERIEUR PORTE [R] TABLE OM'18			
0041	BN32637000SXSE R	BOM.POR.SX C/S H70-1 RON TAV OM'16			
0042	BN32637000SER	BOM.POR.DX C/S H70-1 RON TAV OM'16			

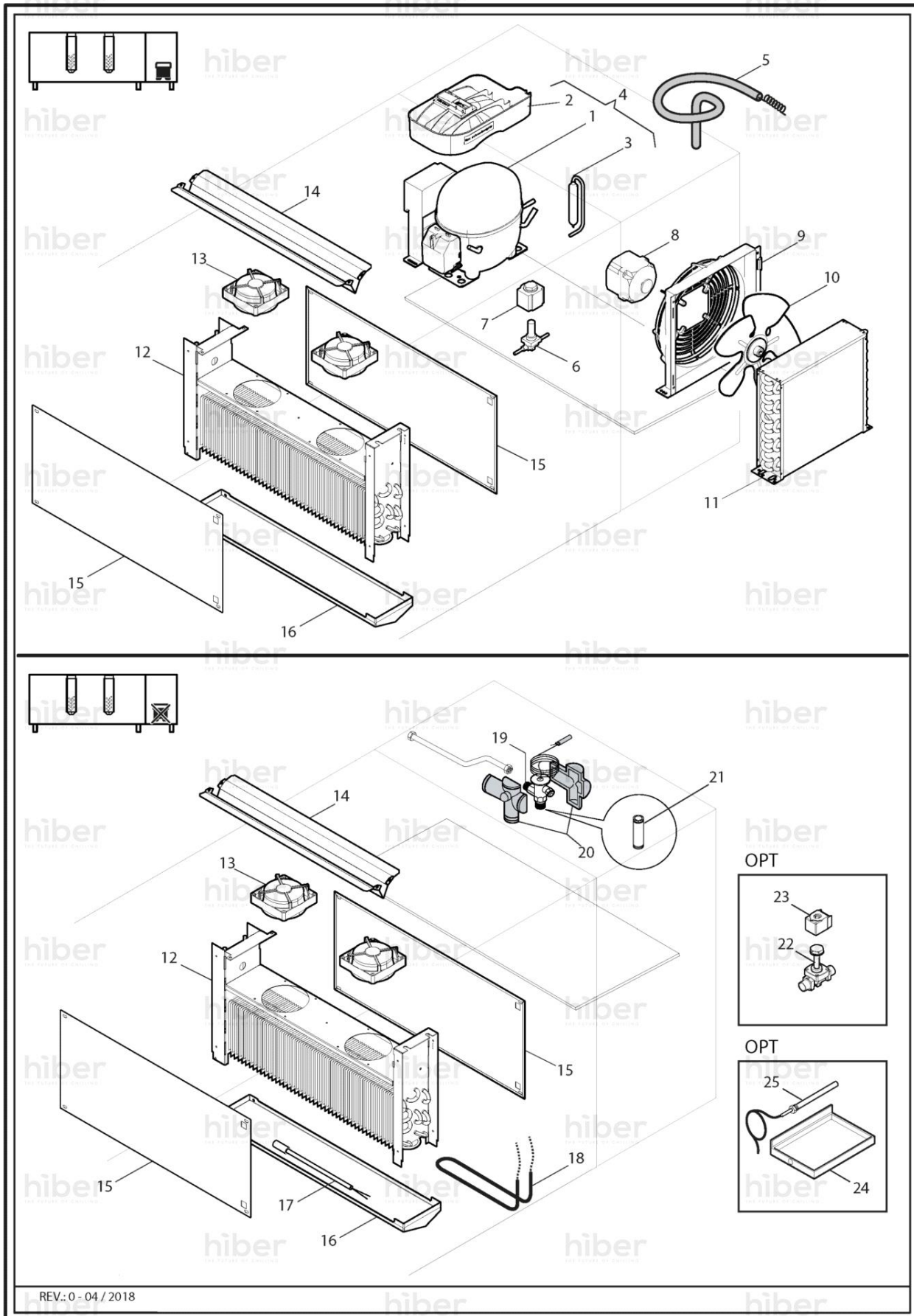

Pos	Réf.	Description	Notes	Valable à p	Valable jus
0001	FR6688220	COMPRESSEUR [R] EMT6170Z R134A 230V 50HZ	R134a		
0002	BN14050300	CUVE [R]			
0003	BN14354110	FILTER 15 GR			
0004	BN2194210	KIT COMPRESS. TNN 3-4V TAV.OW_OK	R134a		
0005	BN14800780	TUBE ECHANG.TABLE OK-OW03-04TNN-BT1.24X2500			
0006	FR6850332	ELECTROVANNE [R]			
0007	FR6851142	BOBINE [R] 220/240V 50/60HZ			
0008	BN1648731513	MOT.VENT.FMI 10/36W + CABLE 1MT			
0009	BN1417005	CONVOGLIATORE IN PLASTICA COND.CG200 EXT			
0010	BN1495230028	TURBINE [R]			
0011	BN141622800029	CONDENSATEUR [R] D'AIR			
0012	BN143301500	EVAPORATEUR TUBI D 7 TNN-BT TAV OK			
0013	BN1648090090	VENTILATEUR			
0014	BN33871500	@DEVIATORE SUPERIORE EVAPORATORE TAV OK			
0015	BN33274300	COPERTURA LATERALE EVAPORATORE TAV OK			
0016	BN14050500	CUVE PLAST. VIDANGE EAU TABLE OK			
0018	BN1666753	RESISTANCE [R] DE DEGIVRAGE 150W			
0019	BN14971702	VALVE [R]	R134A		
0019	FR6851220	VALVE [R]	R452/48/507		
0019	FR6851810	VALV.TZ2 A SALDAR 068Z3502 S/MOP R407C/F	R407C/F		
0019	FR6852060	VALV.TERM.DANF. TUB 1 068U1958 6X12 R410	R410		
0020	BN144551	ISOLATION [R] VALVE D'EXPANSION			
0021	FR6851200	ORIFICE [R] VALVE DE EXPANSION THERMOSTATIQUE			
0022	FR6850332	ELECTROVANNE [R]			
0023	FR6851142	BOBINE [R] 220/240V 50/60HZ			
0024	BN32103056	BAC [R] RECUPERATION			
0025	BN16660901	RESISTANCE [R] 90W 110/265V EVAPORATEUR			

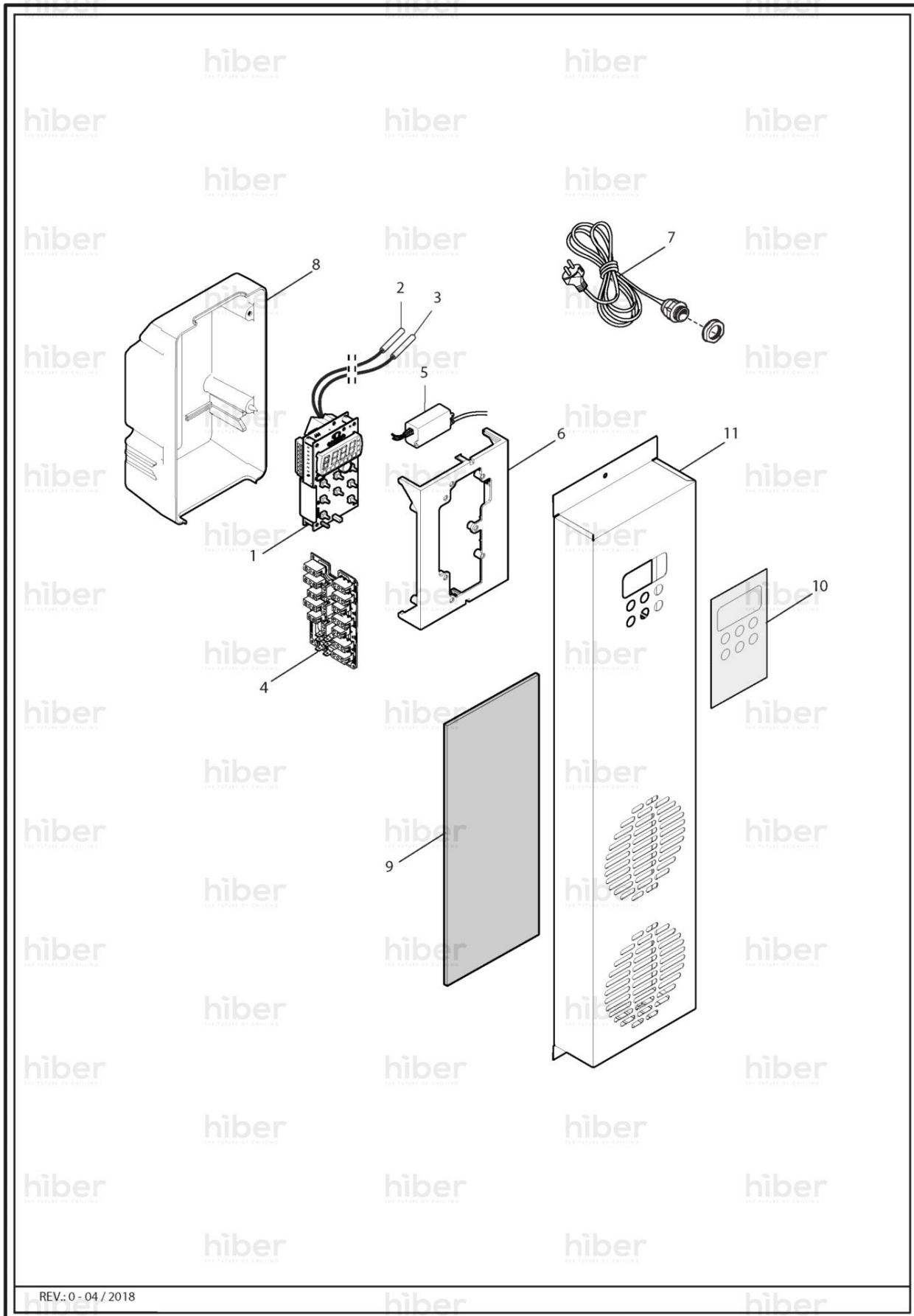

REV.: 0 - 04 / 2018

Pos	Réf.	Description	Notes	Valable à p	Valable jus
0001	BN1681122	THERMOSTAT [R] EVXV224N7FXXX01 VERT.4 REL			
0002	BN167211	SONDE [R] AMBIANCE NTC L. 3 M			
0003	BN167211	SONDE [R] AMBIANCE NTC L. 3 M			
0004	BN1681470	FICHE [R] CÃ,BLAGE 6 CONNECTEURS			
0005	BN168340	TRANSFORM. AC/DC APV-16E-12DI-16W 12V L=330			
0006	BN148255	SUPPORT [R] FICHE			
0007	BN16101561	CABLE [R] L. 4000			
0008	BN148250	PROTECTION [R] FICHE			
0009	BN140420	FILTRE DE L'AIR [R]			
0010	BN14261143	LEXON [R] NEUTRE EN POLYCARBONATE			
0011	BN33574150	MASCH.TERM L=150 OMNIA GEN H71			